

# Bảng thông số sản phẩm

Thông số kỹ thuật



multifunction relay, Harmony Timer Relays, 8A, 1C/O, 0.1s..10 h, power on delay, 24V DC or 24...240V AC DC

RE17RMEMU

## Main

Range of product	Harmony Timer Relays
product or component type	Modular timing relay
Discrete output type	Relay
Width	17.5 mm
Device short name	RE17R
time delay type	Power on-delay Interval Off-delay Symmetrical flashing
time delay range	6...60 min 1...10 min 1...10 s 1...10 h 6...60 s 0.1...1 s
Nominal output current	8 A

## Complementary

Contacts type and composition	1 C/O
Contacts material	Cadmium free
Height	90 mm
Depth	72 mm
Control type	Selector switch front panel
[Us] rated supply voltage	24...240 V AC 50/60 Hz 24 V DC
Voltage range	0.85...1.1 Us
Supply frequency	50...60 Hz +/- 5 %
release of input voltage	10 V
Connections - terminals	Screw terminals, 1 x 0.5...1 x 3.3 mm <sup>2</sup> (AWG 20...AWG 12) solid without cable end Screw terminals, 2 x 0.5...2 x 2.5 mm <sup>2</sup> (AWG 20...AWG 14) solid without cable end Screw terminals, 1 x 0.2...1 x 2.5 mm <sup>2</sup> (AWG 24...AWG 14) flexible with cable end Screw terminals, 2 x 0.2...2 x 1.5 mm <sup>2</sup> (AWG 24...AWG 16) flexible with cable end
Tightening torque	0.6...1 N.m conforming to IEC 60947-1
Housing material	Self-extinguishing
Repeat accuracy	+/- 0.5 % conforming to IEC 61812-1
Temperature drift	+/- 0.05 %/°C
Voltage drift	+/- 0.2 %/V

<b>Setting accuracy of time delay</b>	+/- 10 % of full scale at 25 °C conforming to IEC 61812-1
<b>control signal pulse width</b>	100 ms with load in parallel typical 30 ms typical
<b>Insulation resistance</b>	100 MOhm at 500 V DC conforming to IEC 60664-1
<b>Reset time</b>	120 ms on de-energisation typical
<b>On-load factor</b>	100 %
<b>Power consumption in VA</b>	0...32 VA at 240 V AC
<b>Maximum power consumption in W</b>	0.6 W at 24 V DC
<b>Minimum switching current</b>	10 mA at 5 V DC
<b>Maximum switching current</b>	8 A AC/DC
<b>Maximum switching voltage</b>	250 V AC
<b>Breaking capacity</b>	2000 VA
<b>operating frequency</b>	10 Hz
<b>Electrical durability</b>	100000 cycles (8 A at 250 V AC maximum) for resistive load
<b>Mechanical durability</b>	10000000 cycles
<b>Dielectric strength</b>	2.5 kV 1 mA/1 minute 50 Hz conforming to IEC 61812-1
<b>[Uimp] rated impulse withstand voltage</b>	5 kV during 1.2/50 µs
<b>power on delay</b>	100 ms
<b>marking</b>	CE
<b>Creepage distance</b>	4 kV/3 conforming to IEC 60664-1
<b>Safety reliability data</b>	MTTFd = 296.8 years B10d = 270000
<b>Mounting position</b>	Any position in relation to normal vertical mounting plane
<b>Mounting support</b>	35 mm DIN rail conforming to IEC 60715
<b>Local signalling</b>	LED indicator for on steady: relay energised, no timing in progress LED indicator for flashing: timing in progress 80 % ON and 20 % OFF LED indicator for pulsing: relay de-energised, no timing in progress (except function Di-D, Li-L) 5 % ON and 95 % OFF
<b>Function available</b>	A- Power on-delay relay-1 C/O At- Power on-delay relay w/ pause/summation (Y1)-1 C/O B- Single interval relay w/ control signal-1 C/O C- Off-delay relay w/ control signal-1 C/O D- Symmetrical flashing relay (starting pulse-off)-1 C/O Di- Symmetrical flashing relay (starting pulse-on)-1 C/O H- Interval relay-1 C/O
<b>net weight</b>	0.07 kg
<b>Control type</b>	Without test button
<b>Number of functions</b>	8
<b>Time delay type</b>	A, At, B, C, D, Di, H, Ht
<b>Functionality</b>	Multifunction
<b>Compatibility code</b>	RE17

## Environment

<b>Immunity to microbreaks</b>	20 ms
--------------------------------	-------

<b>Standards</b>	2004/108/EC IEC 61000-6-2 IEC 61000-6-3 IEC 61000-6-1 2006/95/EC IEC 61812-1 IEC 61000-6-4
<b>Product certifications</b>	CSA cULus
<b>Ambient air temperature for storage</b>	-30...60 °C
<b>Ambient air temperature for operation</b>	-20...60 °C
<b>IP degree of protection</b>	IP20 (terminal block) conforming to IEC 60529 IP40 (housing) conforming to IEC 60529 IP50 (front panel) conforming to IEC 60529
<b>Vibration resistance</b>	20 m/s <sup>2</sup> (f= 10...150 Hz) conforming to IEC 60068-2-6
<b>Shock resistance</b>	15 gn for 11 ms conforming to IEC 60068-2-27
<b>Relative humidity</b>	93 % without condensation conforming to IEC 60068-2-30
<b>Electromagnetic compatibility</b>	Electrostatic discharge immunity test: (in contact), level 3, 6 kV, conforming to IEC 61000-4-2 Electrostatic discharge immunity test: (in air), level 3, 8 kV, conforming to IEC 61000-4-2 Susceptibility to electromagnetic fields: (80 MHz to 1 GHz), level 3, 10 V/m, conforming to IEC 61000-4-3 Electrical fast transient/burst immunity test: (capacitive connecting clip), level 3, 1 kV, conforming to IEC 61000-4-4 Electrical fast transient/burst immunity test: (direct), level 3, 2 kV, conforming to IEC 61000-4-4 1.2/50 µs shock waves immunity test: (differential mode), level 3, 1 kV, conforming to IEC 61000-4-5 1.2/50 µs shock waves immunity test: (common mode), level 3, 2 kV, conforming to IEC 61000-4-5 Conducted RF disturbances: (0.15...80 MHz), level 3, 10 V, conforming to IEC 61000-4-6 Voltage dips and interruptions immunity test: (1 cycle), 0 %, conforming to IEC 61000-4-11 Voltage dips and interruptions immunity test: (25/30 cycles), 70 %, conforming to IEC 61000-4-11 Conducted and radiated emissions: , class B, conforming to EN 55022

## Packing Units

<b>Unit Type of Package 1</b>	PCE
<b>Number of Units in Package 1</b>	1
<b>Package 1 Height</b>	2.800 cm
<b>Package 1 Width</b>	7.800 cm
<b>Package 1 Length</b>	9.600 cm
<b>Package 1 Weight</b>	78.000 g
<b>Unit Type of Package 2</b>	S02
<b>Number of Units in Package 2</b>	40
<b>Package 2 Height</b>	15.000 cm
<b>Package 2 Width</b>	30.000 cm
<b>Package 2 Length</b>	40.000 cm
<b>Package 2 Weight</b>	3.700 kg

## Bền vững

Nhãn **Green Premium™** là cam kết của Schneider Electric trong việc cung cấp sản phẩm với hiệu suất môi trường tốt nhất. Green Premium cam kết tuân thủ các quy định mới nhất, minh bạch về tác động môi trường, cũng như các sản phẩm tuần hoàn và CO<sub>2</sub> thấp.

**Hướng dẫn đánh giá tính bền vững của sản phẩm** là tài liệu kỹ thuật phổ thông giúp làm rõ các tiêu chuẩn nhãn sinh thái toàn cầu và cách diễn giải việc khai báo môi trường.

[Tìm hiểu thêm về Green Premium >](#)

[Hướng dẫn đánh giá về sự bền vững của sản phẩm >](#)



Minh bạch [RoHS/REACH](#)

## Hiệu suất sức khỏe

Mercury Free

Rohs Exemption Information [Yes](#)

## Chứng nhận & Tiêu chuẩn

**Reach Regulation** [REACH Declaration](#)

**Eu Rohs Directive** Pro-active compliance (Product out of EU RoHS legal scope)

**China Rohs Regulation** [China RoHS declaration](#)

**Environmental Disclosure** [Product Environmental Profile](#)

**Circularity Profile** [End of Life Information](#)

# Bảng thông số sản phẩm

# RE17RMEMU

Dimensions Drawings

Width 17.5 mm

---

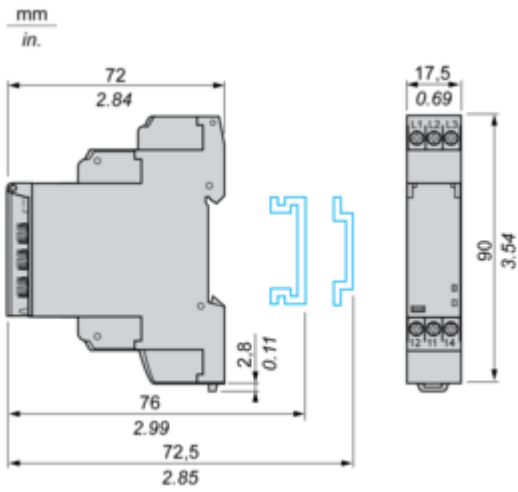

Connections and Schema

Internal Wiring Diagram

---

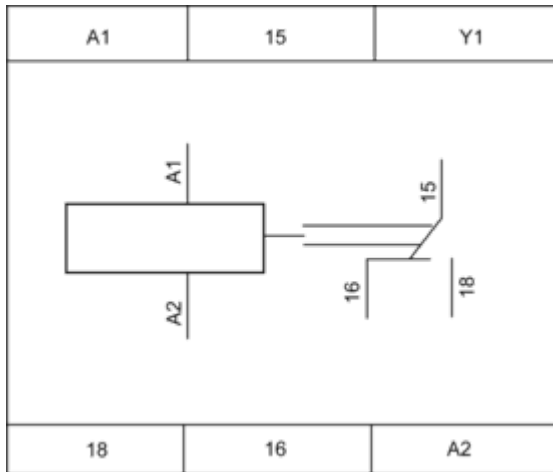

## Wiring Diagram

---

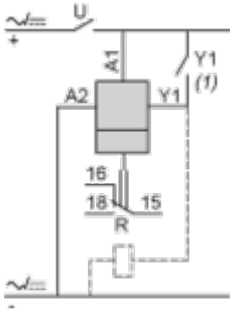

### 1) Contact Y1:

- Control for functions B, C, Ac, Bw, Ad, Ah, N, O, W, T, Tt.
- Partial stop for functions At, Ht and Pt.
- Function D if Di selected.
- Not used for functions A, H and P.

## Technical Description

### Function A : Power on Delay Relay

---

#### Description

The timing period T begins on energisation. After timing, the output(s) R close(s). The second output can be either timed or instantaneous.

#### Function: 1 Output



#### Function: 2 Outputs

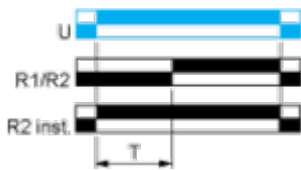

2 timed outputs (R1/R2) or 1 timed output (R1) and 1 instantaneous output (R2 inst.)



**Function At : Power on Delay Relay (Summation) with Control Signal**

---

**Description**

After power-up, the first opening of control contact C starts the timing. Timing can be interrupted each time control contact closes. When the cumulative total of time periods elapsed reaches the pre-set value T, the output relay closes.

**Function: 1 Output**

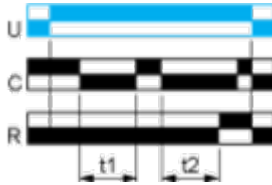

$T = t1 + t2 + \dots$

**Function B : Interval Relay with Control Signal**

---

**Description**

After power-up, pulsing or maintaining control contact C starts the timing T. The output R closes for the duration of the timing period T then reverts to its initial state.

**Function: 1 Output**

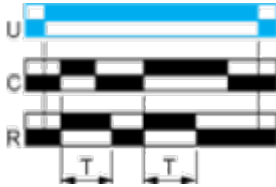

## Function C : Off-Delay Relay with Control Signal

---

### Description

After power-up and closing of the control contact C, the output R closes. When control contact C re-opens, timing T starts. At the end of the timing period, the output(s) R revert(s) to its/their initial state. The second output can be either timed or instantaneous.

### Function: 1 Output

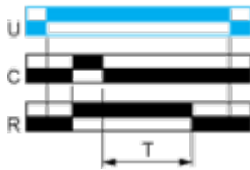

### Function: 2 Outputs

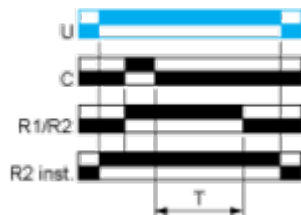

2 timed outputs (R1/R2) or 1 timed output (R1) and 1 instantaneous output (R2 inst.)

## Function D: Symmetrical Flashing Relay (Starting Pulse Off)

---

### Description

On energisation of power supply, output(s) R starts at its/their initial state for timing duration T then change(s) to output(s) R close(s) for the same timing duration T. This cycle is repeated indefinitely until power supply removal. Specially for RE17\*, RE22R2AMU, RE22R2MMW, RE22R2MMU, RE22R2MJU, this D function can only be initiated by energizing Y1 permanently. The second output (R2) can be either timed (when set to "TIMED") or instantaneous (when set to "INST").

### Function: 1 Output

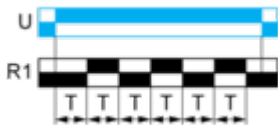

### Function: 2 Outputs

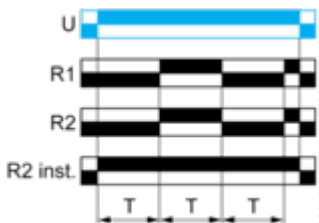

### Function: 1 Output with Retrigger / Restart Control



### Function: 2 Output with Retrigger / Restart Control

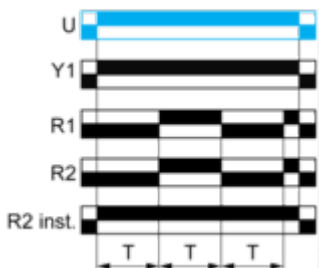

## Function Di : Symmetrical Flasher Relay (Starting Pulse On)

---

### Description

Repetitive cycle with two timing periods  $T$  of equal duration, with output(s)  $R$  changing state at the end of each timing period  $T$ .

The second output can be either timed or instantaneous.

### Function: 1 Output



### Function: 2 Outputs

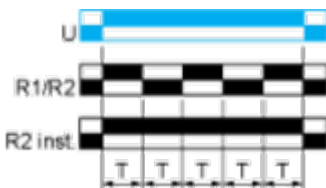

2 timed outputs (R1/R2) or 1 timed output (R1) and 1 instantaneous output (R2 inst.)

## Function H : Interval Relay

---

### Description

On energisation of the relay, timing period T starts and the output(s) R close(s). At the end of the timing period T, the output(s) R revert(s) to its/their initial state. The second output can be either timed or instantaneous.

### Function: 1 Output



### Function: 2 Outputs

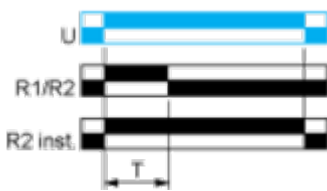

2 timed outputs (R1/R2) or 1 timed output (R1) and 1 instantaneous output (R2 inst.)

## Function Ht: Interval Relay & With Pause / Summation Control

### Description

On energisation of power supply, output(s) R close(s) and timing period T starts.

The timing can be interrupted / paused each time X1 energizes.

When the cumulative total of time periods elapsed reaches the pre-set value T, the output(s) R revert(s) to its/their initial state. Reenergization of X1 will also cause output(s) R close(s) if the time has elapsed and restart the same operation as described at the beginning.

Except for RE17\*, RE22R2MMW, RENF22R2MMW, RE22R2MMU and RE22R2MJU, timing can be interrupted / paused each time Y1 energizes.

The second output (R2) can be either timed (when set to "TIMED" or instantaneous (when set to "INST").

### Function: 1 Output

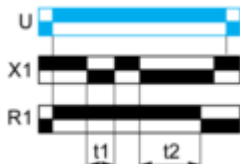

$$T = t1 + t2 + \dots$$

### Function: 2 Outputs

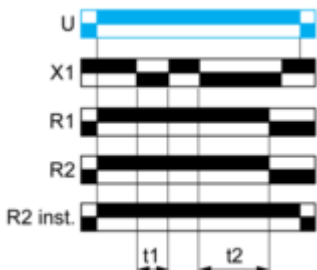

$$T = t1 + t2 + \dots$$

### Function: 1 Output with Retrigger / Restart Control

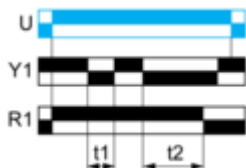

$$T = t1 + t2 + \dots$$



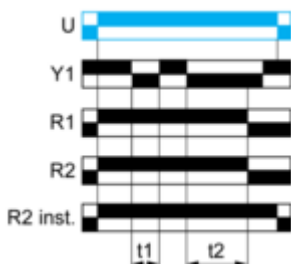

### Function: 2 Outputs with Retrigger / Restart Control



$$T = t1 + t2 + \dots$$

## Legend

---

	Relay de-energised
	Relay energised
	Output open
	Output closed

C	Control contact
G	Gate
R	Relay or solid state output
R1/R2	2 timed outputs
R2 inst.	The second output is instantaneous if the right position is selected
T	Timing period
Ta -	Adjustable On-delay
Tr -	Adjustable Off-delay
U	Supply